

TOSHIBA

Leading Innovation >>>

CAMERA CONTROL UNIT

INSTRUCTION MANUAL

IK-4KE

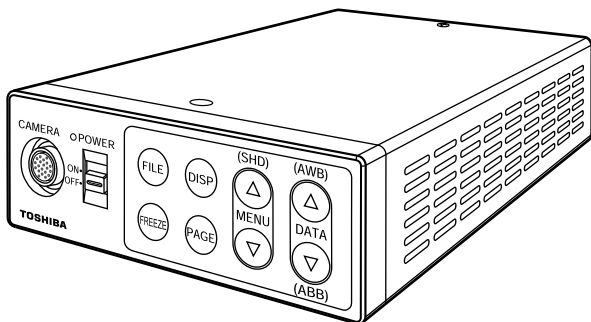

For Customer Use

Enter below the Serial No. which is located on the bottom of the cabinet. Retain this information for future reference.

Model No.: IK-4KE

Serial No.: _____

U.S.A INFORMATION

NOTE: This equipment has been tested and found to comply with the limits for a Class A digital device, pursuant to Part 15 of the FCC Rules. These limits are designed to provide reasonable protection against harmful interference when the equipment is operated in a commercial environment. This equipment generates, uses, and can radiate radio frequency energy and, if not installed and used in accordance with the instruction manual, may cause harmful interference to radio communications. Operation of this equipment in a residential area is likely to cause harmful interference in which case the user will be required to correct the interference at his own expense.

USER-INSTALLER CAUTION: Your authority to operate this FCC verified equipment could be voided if you make changes or modifications not expressly approved by the party responsible for compliance to Part 15 of the FCC Rules.

Following information is only for EU-member states:

In residential areas this product may cause radio interference, therefore this product must not be used in residential areas.

The use of the symbol indicates that this product may not be treated as household waste. By ensuring this product is disposed of correctly, you will help prevent potential negative consequences for the environment and human health, which could otherwise be caused by inappropriate waste handling of this product. For more detailed information about the take-back and recycling of this product, please contact your supplier where you purchased the product or consult.



SAFETY PRECAUTIONS

Safety icons

This manual contains safety instructions that must be observed in order to avoid potential hazards that could result in personal injuries, damage to your equipment, or loss of data.

These safety cautions have been classified according to the seriousness of the risk, and the icons highlight these instructions as follows:

▲ WARNING Indicates a potentially hazardous situation which, if not avoided, could result in death or serious injury.

▲ CAUTION Indicates a potentially hazardous situation which, if not avoided, may result in minor or moderate injury.

CAUTION Indicates a potentially hazardous situation which, if not avoided, may result in property damage.

▲ WARNING **Stop operation immediately if any abnormality or defect occurs.**
Use during an abnormal condition; such as emitting smoke, burning odors, damage from dropping, invasion of foreign objects, etc. may result in fire and/or electric shock. Immediately disconnect the power source and contact your dealer.

▲ WARNING **Avoid installing in a shower room or a bathroom.**
This may result in fire and/or electric shock.

▲ WARNING **Do not operate in places where the product may get wet.**
This may result in fire and/or electric shock.

▲ WARNING **Do not repair, disassemble and/or modify by yourself.**
This may result in fire and/or electric shock. Be always sure to contact your dealer for internal repair, inspection and cleaning of the product.

▲ WARNING **Use the specified power supply.**
Otherwise, fire or electrical shock may occur.

▲ WARNING **Do not place anything on top of the unit.**
Introducing foreign materials, such as metals or liquids into the product may result in fire and/or electrical shock.

▲ WARNING **Do not put the product on an unstable, slanted or vibrating surface.**
If this product is dropped or falls, it may cause serious injury.

▲ WARNING **Do not touch the product or any connection cables during a thunderstorm.**
This may result in electrical shock.

CAUTION**Note the following instructions when installing.**

- Do not cover the product with any material.
- Do not place the product on any confined Inflammable material such as a carpet or blanket.
- Do not place the product in a narrow space, as this may cause heat to buildup inside the product.

Failure to follow the above cautions may result in fire.

CAUTION**Do not place the product in direct sunshine and/or high temperature.**

Temperature build up inside the product may result in fire.

▲ CAUTION**Avoid placing in humid, smoky, vaporized or dusty places.**

This may result in fire and/or electric shock.

▲ CAUTION**Do not block the air vents.**

Temperature build up inside the product may result in fire.

CAUTION**Ask your dealer to perform a periodical check and internal cleaning (approx. once every five years).**

Dust inside the product may result in fire. For inspection and cleaning cost, please consult your dealer.

The following description is for when an IK-4KH camera head is connected to this camera control unit.

▲ CAUTION**Do not point the lens directly at the sun and/or intense light such as direct sunlight, etc.**

Focusing of the light may cause eye injury and/or fire.

Disclaimer

We disclaim any responsibility and shall not be responsible for any damages or losses incurred by the user in any of the following cases:

1. Fire, earthquake or any other act of God; acts by third parties; misuse by the user, whether intentional or accidental; use under extreme operating conditions.
2. Malfunction or non-function resulting in indirect, additional or consequential damages, including but not limited to loss of expected income and suspension of business activities.
3. Incorrect use not in compliance with instructions in this instruction manual.
4. Malfunctions resulting from misconnection to other equipment.
5. Repairs or modifications made by the user or caused to be made by the user and carried out by an unauthorized third party.

Notwithstanding the foregoing, Toshiba America Information Systems, Inc.'s (Toshiba's) liabilities shall not, in any circumstances, exceed the purchase price of the product.

Copyright and Right of Portrait

There may be a conflict with the Copyright Law and other laws when, you, the customer, uses, displays, distributes, or exhibits an image picked up by the camera without permission from the copyright holder. Please also note that transfer of an image or file covered by copyright is restricted to use within the scope permitted by the Copyright Law. You are solely responsible for complying with all applicable copyright laws.

Protection of Personal Information

Images taken by the camera that reveal the likeness of an individual person may be considered personal information. To disclose, exhibit or transmit those images over the internet or otherwise, consent from such individual person may be required. You are solely responsible to obtain such consent.

Limitation of Usage

The product is not designed for any “critical applications.” “Critical applications” means life support systems, exhaust or smoke extraction applications, medical applications, commercial aviation, mass transit applications, military applications, homeland security applications, nuclear facilities or systems or any other applications where product failure could lead to injury to persons or loss of life or catastrophic property damages. Accordingly, Toshiba disclaims any and all liability arising out of the use of the product in any critical applications.

TABLE OF CONTENTS

1. CAUTIONS ON USE AND INSTALLATION	6
2. COMPONENTS	6
3. ITEMS CONTROLLED BY THE SCREEN DISPLAY	7
4. NAMES AND FUNCTIONS	9
5. CONNECTION	10
5.1 Standard Connection	10
5.1.1 In case output mode is 4K	10
5.1.2 In case output mode is 1080p or 1080i.....	11
5.2 Cautions on Connection.....	11
5.3 Connector Pin Assignments.....	12
6. OPERATION	13
6.1 Automatic Black Balance	13
6.2 White Balance.....	13
6.3 Scene File.....	15
6.4 Gain	15
6.5 Shading Correction	16
6.6 Switching of Video Signal Output.....	17
6.7 Freeze operation	17
7. MODE SETTING BY ON SCREEN DISPLAY	18
7.1 Using the Menus	18
7.2 Menus	19
(1) SHUTTER (Electronic shutter).....	19
(1. 1) Changing the setting in AUTO mode	20
(1. 2) Changing the setting in MANUAL mode	22
(1. 3) Changing the setting in SS (Synchro. Scan) mode.....	22

(2) GAIN (Video gain).....	23
(2. 1) Changing the setting in AUTO (AGC: Automatic gain control) mode.....	23
(2. 2) Changing gain in MANUAL mode.....	23
(3) WHT BAL (White balance).....	24
(3. 1) Changing the setting in AWB (Automatic White Balance) mode	24
(3. 2) Changing gain in MANUAL mode.....	25
(4) PROCESS1	26
(4. 1) Changing gamma correction ON/OFF.....	26
(4. 2) Changing gamma correction level	26
(4. 3) Changing black gamma correction level.....	27
(4. 4) Changing the knee correction point.....	27
(4. 5) Changing the knee correction slope.....	27
(4. 6) Changing pedestal.....	28
(4. 7) Change of white clip.....	28
(5) PROCESS2	29
(5. 1) Changing detail (outline) gain.....	29
(5. 2) Change of detail boost frequency.....	29
(5. 3) Change of horizontal and vertical detail balance.....	29
(6) PROCESS3	30
(6. 1) Changing matrix color correction ON/OFF	30
(6. 2) Selection of color for correction	30
(6. 3) Changing HUE and GAIN of selected color.....	30
(6. 4) Changing the total Chroma gain (simultaneously for all colors in the matrix).....	30
(7) SYNC.....	31
(7. 1) INT screen.....	31
(7. 2) Changing EXT. setting	31
(8) OPTION.....	32
(8. 1) Changing shading correction mode.....	32
(8. 2) Changing manual shading correction mode.....	32
(8. 3) Changing detail signal output	32
(8. 4) Change of vertical inversion setting.....	33
(8. 5) Change of horizontal inversion setting.....	33
(8. 6) Switching of inversion mode display.....	33
(8. 7) Changing the FREEZE display.....	33
(8. 8) Changing 4K OSD (On Screen Display) output.....	34
(8. 9) Changing the output mode.....	34
(8. 10) Changing RS-232C baud rate	34
(9) Setting USER area	35
(10) Returning to factory settings.....	36
7. 3 External Sync.....	36
(1) External sync signal input conditions.....	36
(2) External sync frequency range.....	36
(3) Using the unit with external sync signal.....	36
7. 4 Synchro. Scan Operation	36
(1) Setting by 1H.....	36
8. BEFORE MAKING SERVICE CALL.....	37
9. SPECIFICATIONS.....	38
10. EXTERNAL APPEARANCE DIAGRAM.....	39

1. CAUTIONS ON USE AND INSTALLATION

- **Handling the unit.**

Do not drop, jolt, or vibrate, as this may result in damage to the unit and may cause problems. Treat the camera cables carefully to prevent cable problems, such as breaks in the cable and loose connections.

- **Install the camera in a location free from noise.**

If the camera or the cables are located near power utility lines or a TV, etc. undesirable noise may appear on the screen. In such a case, try to change the location of the camera or the cable wiring.

- **Operating ambient temperature and humidity.**

Do not use the camera in places where temperature and humidity exceed the specifications. Picture quality will deteriorate and internal parts may be damaged.

Be particularly careful when using in places exposed to direct sunlight. When shooting in hot environments, depending on the conditions of the object and the camera (for example when the gain is increased), noise in the form of vertical strips or white dots may occur. This is not a malfunction.

- **When not using the camera for extended periods of time.**

Switch the control unit off and disconnect the power supply.

- **Avoid using or storing the camera in the following places:**

Places filled with highly flammable and corrosive gas.

Places near gasoline, benzene, or paint thinner.

Places subject to strong vibration.

Places containing chemicals (such as pesticides), rubber or vinyl products for extended periods of time.

- **This product is for indoor use only.**

The following descriptions are for a camera head "IK-4KH" connected to this camera control unit.

- **Do not shoot intense light.**

If a strong light is imaged, vertical stripes or traverse bands may appear on the screen but this is not a failure.

- **Moire**

A moire pattern is an interference pattern generated when two repetitive line patterns overlap. This is not a malfunction. Eliminating the repetitive line patterns, or aligning the two patterns, will eliminate the moire.

- **Handling of the camera head and protection cap.**

Keep the camera head and protection cap away from children as they may pose a choking hazard.

The protection cap protects the image sensing plane when the lens is removed from the camera head, do not discard the protection cap.

- **When cleaning the camera.**

Unplug the power source before cleaning. Clean with a soft dry cloth only. Do not use chemicals or chemically treated cloths. Chemicals may damage coatings and printed letters. When cleaning the lens, use lens cleaning paper.

- **Installation without a tripod.**

Before installing the camera head, make sure that the location can withstand the total weight of the camera head.

If this is not the case, reinforce the area to prevent the unit from dropping, which may result in damage to the unit or personal injury.

2. COMPONENTS

(1) Camera Control Unit	1
(2) Accessories	
(a) Instruction manual	1

3. ITEMS CONTROLLED BY THE SCREEN DISPLAY

Item		Available selections	Preset value (Factory setting)
Electronic shutter	MODE	AUTO, MANUAL, SS	MANUAL
	AUTO level	-100 – 0 – 100	0
	AUTO exposure metering	PEAK/AVE, MEDIAN	PEAK/AVE
	AUTO peak/average	00 : 10 – 10 : 00	00 : 10
	AUTO response speed	1 – 10 – 20	10
	AUTO area	PRESET A, PRESET B, PRESET C, PRESET D, PRESET E, USER (USER area is possible to set in 64 zones)	PRESET A
	Maximum AUTO shutter speed	1/200s, 1/250s, 1/300s, 1/350s, 1/400s, 1/450s, 1/500s, 1/550s, 1/600s, 1/700s, 1/800s, 1/900s, 1/1000s, 1/1200s, 1/1500s, 1/2000s, 1/4000s, OFF	OFF
	MANUAL shutter speed	OFF, 1/100s, 1/125s, 1/250s, 1/500s, 1/1000s, 1/2000s, 1/3000s, 1/4000s, 1/5000s, 1/10000s	OFF
Syncro. scan	1/1125H – 1124/1125H, OFF	OFF	
Gain	MODE	AUTO, MANUAL, OFF	OFF
	AUTO maximum gain	0dB to 24dB	24dB
	AUTO minimum gain	-6dB to 0dB	-6dB
	MANUAL gain	-6dB to 24dB	0dB
White balance	MODE	AWB, MANUAL	AWB
	Color temperature	3200K, 5600K	3200K
	AWB R PAINT	-10 – 0 – 10	0
	AWB B PAINT	-10 – 0 – 10	0
	AWB area	PRESET A, PRESET B, PRESET C, PRESET D, PRESET E, USER (USER area is possible to set in 64 zones)	PRESET A
	MANUAL R GAIN	-100 – 0 – 100	0
	MANUAL B GAIN	-100 – 0 – 100	0
Gamma correction	ON, OFF	ON	
Gamma correction level	-10 – 0 – 10	0	
Black gamma correction level	LOW, NORMAL, HIGH	NORMAL	
Knee correction point	70%, 75%, 80%, 85%, 90%, 95%, 100%	85%	
Knee correction slope	1 – 8 – 16	8	
Master pedestal	-200 – 0 – 200	0	
Red pedestal	-100 – 0 – 100	0	
Blue pedestal	-100 – 0 – 100	0	
White clip	100% – 109%	109%	
Detail gain	0 – 10 – 31	10	
Detail boost frequency	1 – 10 – 16	16 (4K mode)	
		10 (1080p mode) (1080i mode)	
HV balance	8/16 – 16/16 – 24/16 (ratio of V/H)	16/16	
Matrix	Correction ON/OFF	ON, OFF	ON
	Selection of correction color	R, R-Ye, Ye, Ye-G, G, G-Cy, Cy, Cy-B, B, B-Mg, Mg, Mg-R	R
	Hue	-15 – 0 – 15	0
	Gain	-15 – 0 – 15	0
Chroma gain	-31 – 0 – 31	0	
Ext. Sync	H phase adjustment	-650 – 0 – 650	0
Shading correction mode	SET, MANUAL, OFF	OFF	
Manual shading correction	-128 – 0 – 127	0	
Detail signal output	ON, OFF	OFF	
Vertical inversion	ON, OFF	OFF	
Horizontal inversion	ON, OFF	OFF	
Inversion mode display switch	ON, OFF	OFF	

Item	Available selections	Preset value (Factory setting)
Changing the FREEZE display	ON, OFF	ON
4K OSD output	A, B, C, D	A
Output mode	4K, 1080p, 1080i	4K
RS-232C baud rate	9600bps, 19200bps	9600bps

4. NAMES AND FUNCTIONS

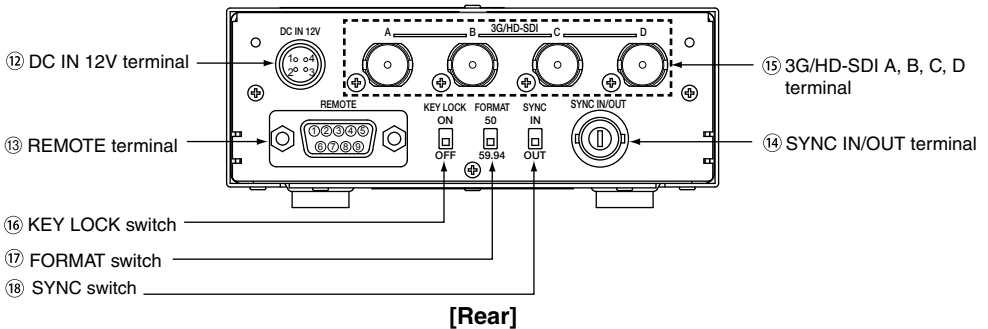
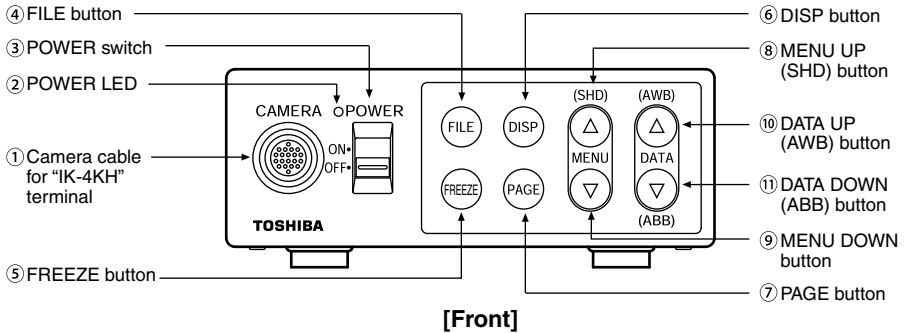

- | | |
|--------------------------------------|---|
| ① Camera cable for "IK-4KH" terminal | Where the camera cable for "IK-4KH" is connected. |
| ② POWER LED | Illuminates to indicate the unit is powered on. |
| ③ POWER switch | Turns power on or off. |
| ④ FILE button | To switch the scene files. |
| ⑤ FREEZE button | To freeze the display. |
| ⑥ DISP button | Changes the display mode. |
| ⑦ PAGE button | To switch and select menus. |
| ⑧ MENU UP (SHD) button | To select the function to be confirmed or changed on the menu. (Also used when performing auto shading correction.) |
| ⑨ MENU DOWN button | To select the function to be confirmed or changed on the menu. |
| ⑩ DATA UP (AWB) button | To change the value of the function selected by the MENU (UP/DOWN) button. (Also used when performing an AWB.) |
| ⑪ DATA DOWN (ABB) button | To change the value of the function selected by the MENU (UP/DOWN) button. (Also used when performing an ABB.) |

- ⑫ DC IN 12V terminal Accepts a DC power input (12V).
- ⑬ REMOTE terminal To connect to a RS-232C device for remote control function.
- ⑭ SYNC IN/OUT terminal Used when the camera output signal is synchronized to an external signal or when a synchronized signal is output. (BNC connector)
- ⑮ 3G/HD-SDI A, B, C, D terminal Image signal output terminal for 3G/HD-SDI formats. (BNC connector)
- ⑯ KEY LOCK switch Enables/disables buttons ④ to ⑪.
- ⑰ FORMAT switch Switches between 59.94Hz and 50Hz.
- ⑱ SYNC switch Switches between input and output of synchronized signals from SYNC IN/OUT terminals in ⑭.

5. CONNECTION

5.1 Standard Connection

5.1.1 In case output mode is 4K

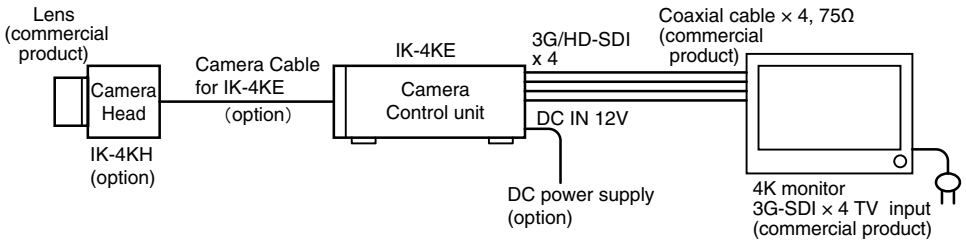

* 3G/HD-SDI A, B, C, D terminals and screen positioning are shown below.

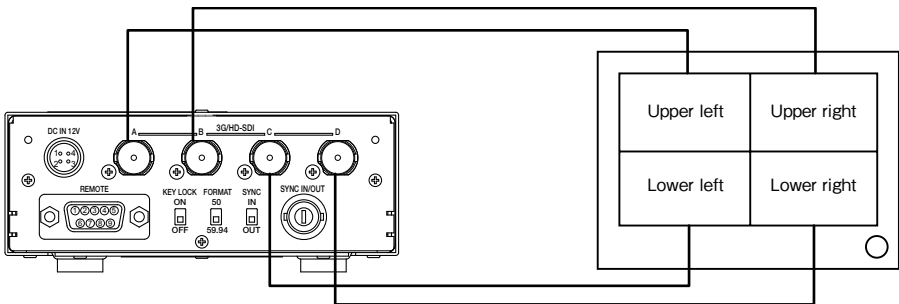

5. 1. 2 In case output mode is 1080p or 1080i

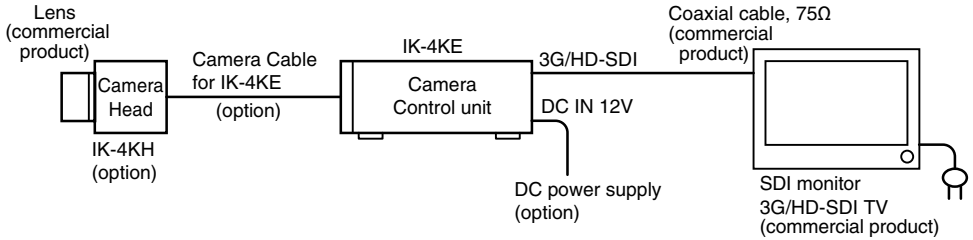

* 3G/HD-SDI A, B, C, D terminals output the same signal.

5. 2 Cautions on Connection

- When connecting the camera cables, be sure to turn off the camera control unit and any other equipment connected to it.
- For DC power supply connecting to DC IN 12V terminal, use class II DC power supply approved according to EN60950-1 in Europe. or use UL listed and/or CSA approved ungrounded type AC adaptor with the specifications described below in U.S.A. or Canada.

Power supply voltage : 12V DC $\pm 10\%$
Current rating : More than 1.5A
Ripple voltage : Less than 50 mV (p-p)
Connector : HR10A-7P-4S by HIROSE electronics Co. Ltd
Pins 1, 2 : +12V
Pins 3, 4 : GND

- If the securing screw on the connector of the camera cable loosens, noise may appear on the screen. Be sure to tighten the connector completely.
- Only use the specific optional camera heads with this camera controller.
The use of any other camera heads may cause damage to the control unit and camera head.
- The video signal output of this camera control unit has no function for automatically selecting output according to the monitor TV. Therefore, be sure to switch the output mode of this camera control unit according to the monitor as no image will be displayed on the monitor if the camera output mode and the monitor input mode do not match. For switching, refer to the item 6.6 "Switching of Video Signal Output".
- SDI interface
The SDI (serial digital interface) is a high-speed serial interface standard used mainly in commercial video equipment. This unit supports both HD-SDI and 3G-SDI.
When image output is "4K" or "1080p", 3G-SDI output is used. When image output is "1080i", HD-SDI output is used.
Use a 3G/HD-SDI compatible cable to connect to the 3G/HD-SDI terminal.

Note:

The image may not appear on the monitor's screen immediately, depending on the conditions and the type of monitor.

5.3 Connector Pin Assignments

The rear panel of the camera control unit has the following connectors:

DC IN 12V; REMOTE; SYNC IN/OUT and 3G/HD-SDI A, B, C, D terminals. Use the appropriate cables to connect with these connectors.

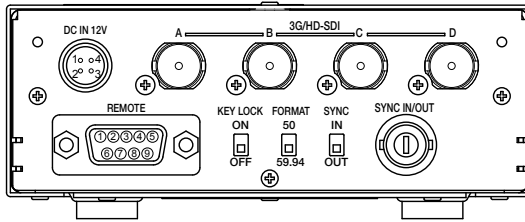

DC IN 12V terminal

1	+12V
2	+12V
3	GND
4	GND

REMOTE terminal

1	-
2	TXD
3	RXD
4	-
5	GND
6	-
7	-
8	-
9	-

6. OPERATION

A camera head needs to be connected to this camera control unit from this section on.

- ① Refer to the item "5. CONNECTION", connect the equipment correctly.
- ② Turn on the connected equipment and the camera.
- ③ When using the camera for the first time and when replacing the camera head, be sure to perform the ABB adjustment, refer to the item "6.1 Automatic Black Balance".
- ④ Aim the lens at the object, adjust the lens iris adjustment, focus adjustment, etc.
- ⑤ Refer to the item "6.2 White Balance", make the adjustment.
- ⑥ Refer to the items "6.3 Scene File, 6.4 Gain, 7. MODE SETTING BY THE ON SCREEN DISPLAY", select the necessary items.

6.1 Automatic Black Balance

Black balance adjustment is necessary to get the correct black picture level.

- Close the lens iris.
- If the color bar pattern is displayed on the screen or if the index menu/menu is displayed, press the [DISP] button to disable the color bar pattern or the character display.
- Hold the [DATA DOWN] button for approx. 1 second.
- When the black balance adjustment operation starts, the character ABB blinks on the screen.
- When the black balance adjustment operation finishes, the character ABB stops blinking and the result appears for approx. 1 second.

Display	Meaning
ABB OK	Automatic black balance adjustment finished correctly.
ABB NG CLOSE LENS	Automatic black balance adjustment cannot be performed because the lens iris is open. Close the lens iris.
ABB NG	Automatic black balance adjustment cannot be performed. Operate the automatic black balance again.

6.2 White Balance

For white balance adjustment of this unit, AWB (Automatic White Balance) and MANUAL (Manual white balance) adjustments are provided. Refer to the items "7.2 (3) WHT BAL (White balance), 7. MODE SETTING BY ON SCREEN DISPLAY", select the desired mode.

	AWB (Automatic White Balance)	MANUAL (Manual White Balance)
Outline	Adjust white balance by displaying a white object inside the area set by AWB menu and hold the [DATA UP] button for approx. 1 second.	Adjust the white balance manually using the WHT BAL menu while shooting a white object.
Features	Automatically adjusts red and blue balance based on green for the object in the designated area.	White balance can be set manually.
Note	When no white object exists in the designated area or lighting is too bright or too dark, AWB NG is displayed and automatic white balance adjustment can not be performed.	Adjustment is performed by confirming with a monitor etc.

① AWB (Automatic white balance)

- Set the MODE to AWB on the WHT BAL menu.
Change the C.TEMP (color temperature conversion) setting, if necessary.
(Refer to the item “7.2 (3) WHT BAL (White balance)”.)
- 3200K : Appropriate for indoor shooting.
- 5600K : Appropriate for outdoor shooting.
- If the color bar pattern is displayed on the screen or if the index menu/menu is displayed, press the [DISP] button to disable the color bar pattern or the character display on the monitor.
- Shoot a known white object entirely in the area set by the AWB menu (refer to the item “7.2 (3) (3.1) (d) Changing the contents of the zone area selected by AWB”) and push [DATA UP] button for approx. 1 second.
- The character AWB blinks on the screen when the AWB starts.
- The character AWB stops blinking when the AWB finishes, and the result is displayed for approx. 1 second.

Display	Meaning
AWB OK	Automatic white balance adjustment finished correctly.
AWB NG LEVEL LOW	Automatic white balance adjustment cannot be performed because the video level is too low. Adjust the video level by increasing the illumination or opening the lens iris.
AWB NG LEVEL HIGH	Automatic white balance adjustment cannot be performed because the video level is too high. Adjust the video level by decreasing the illumination or closing the lens iris.
AWB NG C. TEMP LOW	Automatic white balance adjustment cannot be performed because the color temperature is too low. If the C.TEMP is set to 5600K, set to 3200K. If the message appears with the C.TEMP set to 3200K, change the illumination or use a color temperature conversion filter.
AWB NG C. TEMP HIGH	Automatic white balance adjustment cannot be performed because the color temperature is too high. If the C.TEMP is set to 3200K, set to 5600K. If the message appears with the C.TEMP set to 5600K, change the illumination or use the color temperature conversion filter.
AWB NG	Automatic white balance adjustment cannot be performed for other reasons, such as no white area is included in an object, etc.

② MANUAL (Manual white balance)

- Set the MODE to MANUAL on the WHT BAL menu.
(Refer to the item “7.2 (3) WHT BAL (White balance)”.)
- Shoot a known white object, set the white balance by adjusting the levels of R GAIN and B GAIN on the menu, confirming with a monitor or a vector scope.
(Refer to the item “7.2 (3) (3.2) Changing gain in MANUAL mode”.)

6.3 Scene File

Five scene files (A, B, C, D, E) are available as user memories for this unit. These are chosen depending on shooting conditions. By using the [FILE] button, the camera operation is changed immediately from the currently selected Scene File to the next. (Refer to the item "7. MODE SETTING BY ON SCREEN DISPLAY".)

- While any menu is displayed, pressing the [FILE] button will display the menu settings for the next Scene File:



- If the color bar pattern is displayed on the screen, press the [DISP] button to switch to the video signal screen.
- When the [FILE] button is pressed while the video signal screen is displayed, the current scene file selection at that time is displayed for approx. 3 seconds in the upper right corner of the screen. If the [FILE] button is pressed again while the position is displayed, the scene file cycles as described above.

Note:

The scene file does not include the data set in "OUTPUT MODE" "BAUD RATE" within the "OPTION" menu. Refer to the item "7.2 (8) OPTION" for the contents that can be set in OPTION.

6.4 Gain

When the image is dark even if the lens iris is open, change the gain (video gain) to get the desired video level. For gain adjustment of the unit, AUTO (Automatic gain control), MANUAL (Manual gain control), OFF (0 dB) modes are provided. Select the mode on the GAIN menu. (Refer to the item "7.2 (2) GAIN (Video gain)".)

① AUTO (Automatic gain control)

When the output is low, gain is automatically adjusted to a suitable video level.

You can set a value for the maximum gain from 0 dB to 24 dB in 1 dB increments. You can set a value for the minimum gain from -6 dB to 0 dB in 1 dB increments. (Refer to 7.2 (2) (2.1) "Changing the setting in AUTO (AGC: Automatic gain control) mode.")

Video level (LEVEL), exposure metering (PHOTOMETRY), peak average value ratio (PEAK/AVE), measurement light area (AREA), and response speed (SPEED) are linked to the setting on the automatic shutter. (Refer to the item "7.2 (1) (1.1) Changing the setting in AUTO mode".)

② MANUAL (Manual gain)

Gain adjustment is performed on the GAIN menu. The adjustment range is from -6 to 24dB in 1dB steps. (Refer to the item "7.2 (2) (2.2) Changing gain in MANUAL mode".)

③ OFF

Gain is fixed at 0 dB.

Note:

White, red, green, or blue dots may occur when the gain is increased. This is not a malfunction, just certain characteristics of the CMOS sensor becoming more visible.

6.5 Shading Correction

Due to the lens used or the environmental condition, color shading may occur at the upper and lower edge of the screen. If this happens, the shading correction function can be used to decrease the amount of color shading. For shading correction of the unit, SET (Automatic shading correction), MANUAL (Manual shading correction), and OFF (no shading correction) modes are provided. Select the mode on the OPTION menu. (Refer to the item “7.2 (8) (8.1) Changing shading correction mode”.)

① SET (Auto shading)

- If the color bar pattern is displayed on the screen or if the index menu/menu is displayed, press the [DISP] button to remove them from the screen.
- Push the [MENU UP] button for approx. 1 second.
- When the automatic shading correction operation starts, the character SHD blinks on the screen.
- When the automatic shading correction operation terminates, the character SHD ends blinking and the result is displayed for approx. 1 second.

Display	Meaning
SHD OK	Automatic shading correction operation finished correctly.
SHD OK LIMIT	Automatic shading correction operation finished, however, the correction necessary exceeds the camera's range so the maximum possible value is applied.
SHD NG LEVEL LOW	Automatic shading correction cannot be performed because the video level is too low. Adjust the video level by increasing the illumination or opening the lens iris.
SHD NG LEVEL HIGH	Automatic shading correction cannot be performed because the video level is too high. Adjust the video level by decreasing the illumination or closing the lens iris.

② MANUAL (Manual shading)

Perform the correction on the OPTION menu, confirming with a monitor or a vector scope.
(Refer to the “7.2 (8) (8.2) Changing manual shading correction mode”.)

③ OFF

No shading correction is performed.

* Shading correction is only effective when the lens iris and zoom ratio is fixed. Use the unit with SHADING OFF for variable lens conditions.

Note:

Implement shading correction after white balance adjustment by shooting a white object that fills the screen in the proper video level.

6.6 Switching of Video Signal Output

① Switching of OUTPUT modes

The image output can be changed between “4K”, “1080p”, or “1080i” by turning on the controller while pushing the [MENU DOWN], [DATA UP], or [DATA DOWN] button.

- Turn on the controller while pushing the [MENU DOWN] button. The image output becomes “4K”, and “4K” is displayed on the monitor screen.
- Turn on the controller while pushing the [DATA UP] button. The image output becomes “1080p”, and “1080p” is displayed on the monitor screen.
- Turn on the controller while pushing the [DATA DOWN] button. The image output becomes “1080i”, and “1080i” is displayed on the monitor screen.

Note:

The image may not appear on the monitor's screen immediately after switching the output mode.

② Switching of vertical frequency

Adjust the FORMAT switch to the “59.94” position for switching to “59.94Hz”.

Adjust the FORMAT switch to the “50” position for switching to “50Hz”.

(Refer to the item “4. NAMES AND FUNCTIONS, ⑰ FORMAT switch”.)

6.7 Freeze Operation

- The display can be frozen in the case of a video signal only on a normal screen. The display cannot be frozen in the case of the color bar pattern, or index menu/menu.
- Each press of the [FREEZE] button toggles between freeze display and normal display.
- If ON is selected for the FREEZE DISP setting on the OPTION menu, “FREEZE” is displayed while the display is frozen. (Refer to (7.2 (8) (8.7) “Changing the FREEZE display.”)
- The following keys are disabled while the display is frozen: [FILE], [DISP], [PAGE], [MENU UP], [MENU DOWN], [DATA UP], and [DATA DOWN].

7. MODE SETTING BY ON SCREEN DISPLAY

Various settings can be controlled on the unit by using the on screen menu displayed on the monitor. The contents once set are memorized in the scene files (A, B, C, D, E) selected, so if the power turns off, it is unnecessary to set again when using the unit next time. When the setting is performed, select the menu of the item to be set.

Note

- Displayed texts while pressing the on screen menu, auto white balance (AWB) or other menus are present on the output video. These texts on the video are not removable after the video is recorded. Therefore, be aware when you operate the on screen menu, AWB and other menus.
- In the 4K output mode, you can change the position of text displayed during operation of screen menus, AWB (auto white balance), etc. Refer to (7.2 (8) (8.8) "Changing 4K OSD (On Screen Display) output." In the 1080p and 1080i modes, text is displayed over the entire screen, you cannot change the position of the text.

7.1 Using the Menus

When the power turns on, the normal screen showing only the video signal appears. Change the output to each screen (video signal output, color bar screen, Index menu, menus, and area menu) by using the [DISP], [PAGE], [MENU UP], and [MENU DOWN] buttons.

* A menu is selected when pushing the [PAGE] button after moving the "→" on the screen by the [MENU UP], [MENU DOWN] button while the Index menu is displayed.

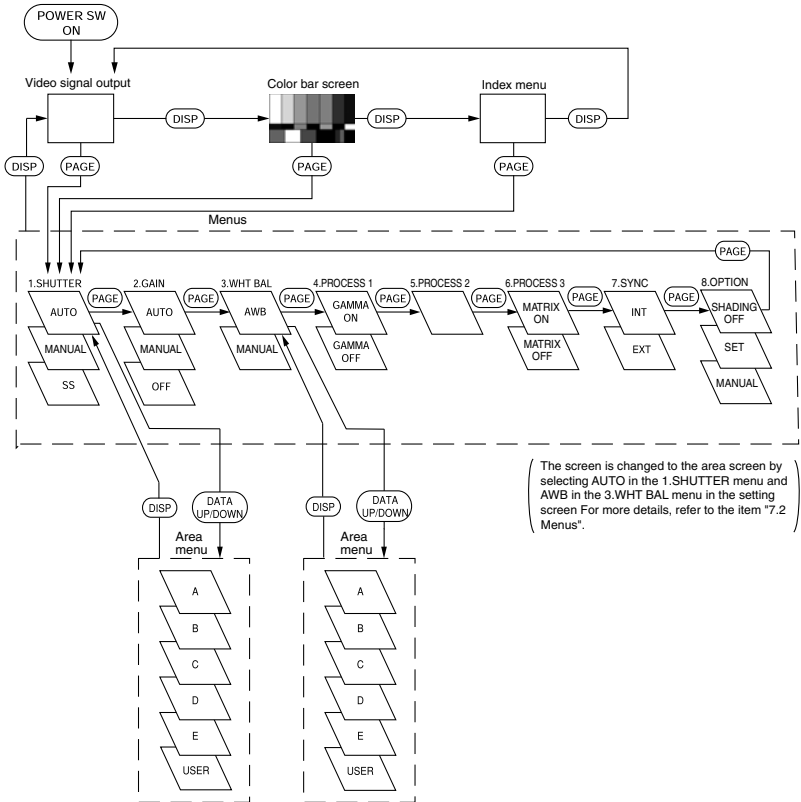

7.2 Menus

- ① Select the menu to change the setting by referring to the item “7.1 Using the Menu”.
- ② When the [MENU UP], [MENU DOWN] buttons are pushed, the “→” on the screen moves up and down. Move the “→” to the item whose setting you wish to change.
- ③ Use the [DATA UP], [DATA DOWN] buttons to make changes.

(1) SHUTTER (Electronic shutter)

The electronic shutter has three modes; AUTO, MANUAL, SS (Synchro. Scan).

Press the “Page” button to enter the Shutter Page. Use the “Data Up/Down” buttons to select the Shutter Mode.

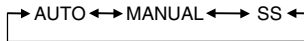

AUTO : The exposure time is controlled automatically to obtain the optimum video level.

MANUAL : It is possible to select the exposure time from eleven speed settings; OFF (at 1/60s: 59.94Hz setting and 1/50s: 50Hz setting), 1/100s, 1/125s, 1/250s, 1/500s, 1/1000s, 1/2000s, 1/3000s, 1/4000s, 1/5000s, 1/10000s.

SS : Shutter speed can be set by the horizontal scanning time (1H) unit.

Notes:

- If the shutter speed is increased, the sensitivity is decreased according to the speed. Flicker may occur under discharge lamp lighting such as fluorescent tubes.
- If a fast-moving object is shot, its image may be distorted or blurred. Horizontal light-and-dark stripes may appear on the screen under discharge lamp lighting such as fluorescent tubes. A light and dark difference may appear on the screen according to the light emitting timing of flash or strobe. These phenomena are due to rolling shutter system, not failures.
- When the shutter speed is set to high, the hue may change according to the shooting conditions and the object.

(1. 1) Changing the setting in AUTO mode

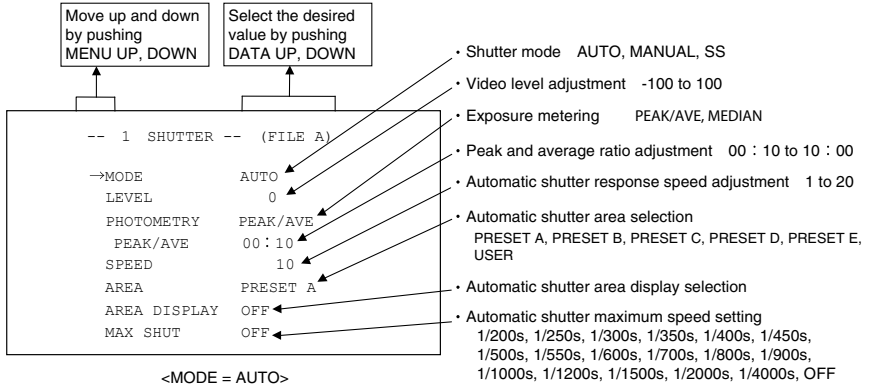

(a) Changing the video level in the automatic shutter mode

- ① Move the "→" to LEVEL by pushing the [MENU UP], [MENU DOWN] buttons.
- ② Select the video level by pushing the [DATA UP], [DATA DOWN] buttons.



(b) Changing the exposure metering of the automatic shutter

- ① Move the "→" to PHOTOMETRY by pushing the [MENU UP], [MENU DOWN] buttons.
- ② Select PEAK/AVE or MEDIAN by pushing the [DATA UP], [DATA DOWN] buttons.

If PEAK/AVE is selected, the exposure is a ratio of the peak and average values shown in PEAK/AVE.

If MEDIAN is selected, there is less variation in the brightness than when PEAK/AVE is selected, such as for scenes with large changes in background brightness.

(c) Changing the automatic shutter detection (ratio between peak and average value)

- ① Move the "→" to PEAK/AVE by pushing the [MENU UP], [MENU DOWN] buttons.
- ② Select the ratio between peak and average value by pushing the [DATA UP], [DATA DOWN] buttons.

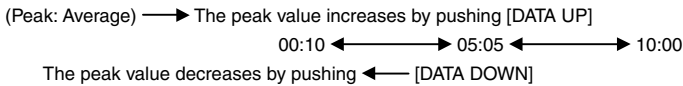

*If MEDIAN is selected for PHOTOMETRY, the PEAK/AVE display disappears, so it cannot be changed.

(d) Changing the automatic shutter response speed

- ① Move the "→" to SPEED by pushing the [MENU UP], [MENU DOWN] buttons.
- ② Select the response speed by pushing the [DATA UP], [DATA DOWN] buttons.

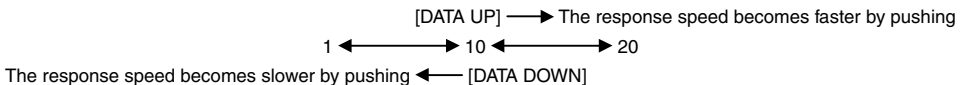

(e) Changing the automatic shutter zone area

- ① Move the “→” to AREA by pushing the [MENU UP], [MENU DOWN] buttons.
- ② Select the measurement light area by pushing the [DATA UP], [DATA DOWN] buttons.

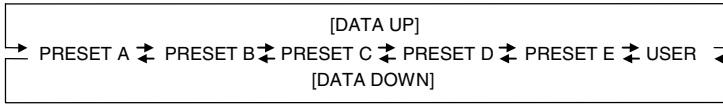

The dark squares indicate the effective region of the image, which is divided into an 8 x 8 grid.

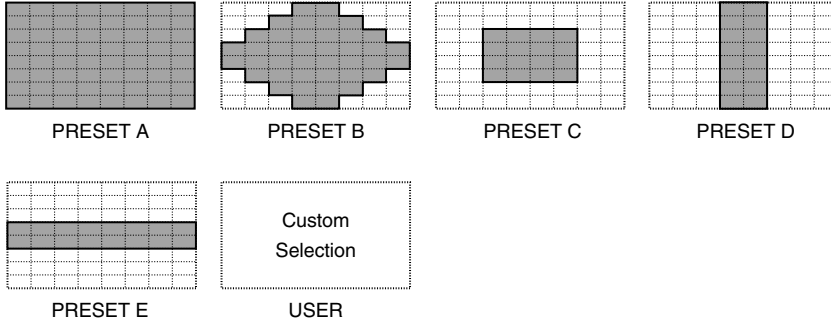

(f) Confirming the contents of the measurement light area selected by the automatic shutter

- ① Move the “→” to AREA DISPLAY by pushing the [MENU UP], [MENU DOWN] buttons.
- ② Area screen appears by pushing the [DATA UP], [DATA DOWN] buttons.
When AREA is set to USER, the setting can be changed on the area menu. When changing the area, refer to the item “7.2 (9) Setting USER area”.
- ③ Push the [DISP] button to return to the menu.

(g) Setting of maximum auto shutter speed

- ① Move the “→” to MAX SHUT by pushing the [MENU UP], [MENU DOWN] buttons.
- ② Select the shutter speed by pushing the [DATA UP], [DATA DOWN] buttons.



(1.2) Changing the setting in MANUAL mode

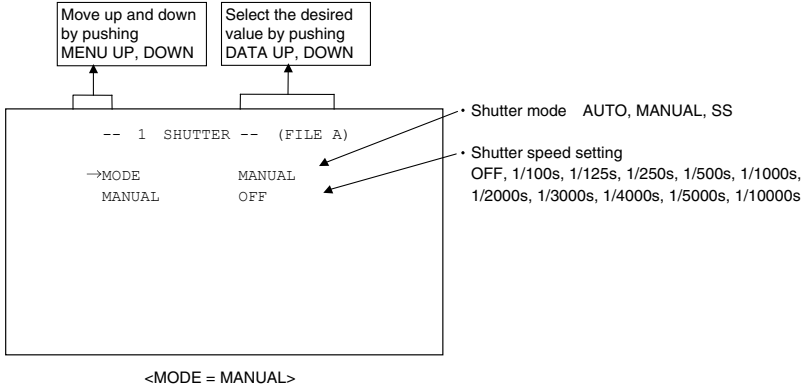

(a) Changing the shutter speed

- ① Move the "→" to MANUAL by pushing the [MENU UP], [MENU DOWN] buttons.
- ② Select the shutter speed by pushing the [DATA UP], [DATA DOWN] buttons.

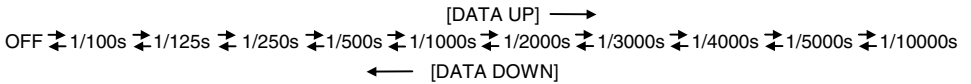

(1.3) Changing the setting in SS (Synchro. Scan) mode

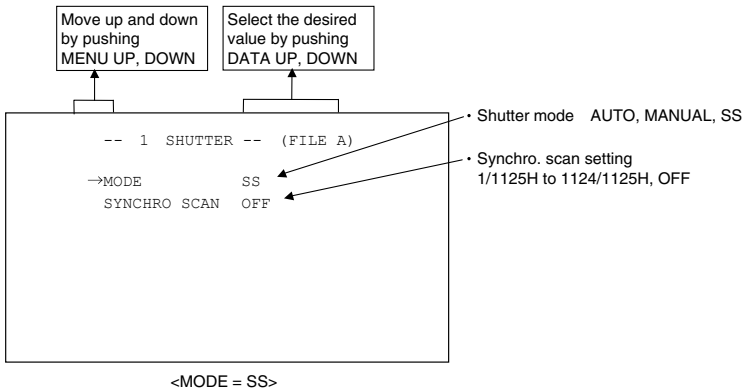

(a) Changing the Synchro. Scan setting

- ① Move the "→" to SYNCHRO SCAN by pushing the [MENU UP], [MENU DOWN] buttons.
- ② Select the Synchro. Scan by pushing the [DATA UP], [DATA DOWN] buttons.

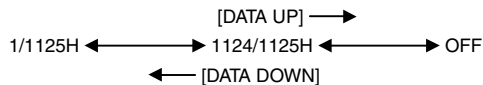

(2) GAIN (Video gain)

GAIN has three modes; AUTO, MANUAL, OFF.

Move the “→” to MODE, push the [DATA UP], [DATA DOWN], and select one of the three modes: AUTO, MANUAL, OFF. In the OFF mode, gain is fixed to 0dB.

(2.1) Changing the setting in AUTO (AGC: Automatic gain control) mode

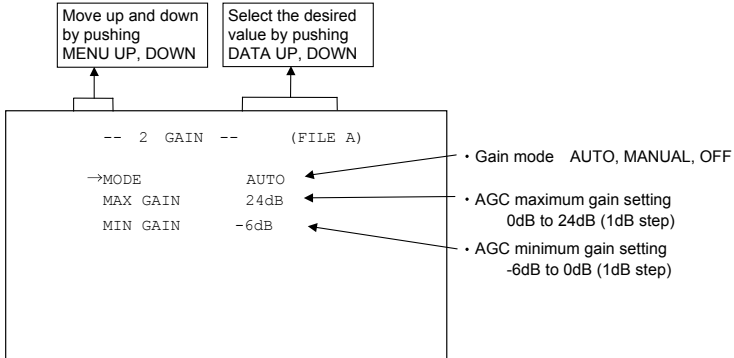

(a) Changing the maximum gain

- Move the “→” to MAX GAIN by pushing the [MENU UP], [MENU DOWN] buttons.
- Select the desired value of AGC maximum gain by pushing the [DATA UP], [DATA DOWN] buttons.

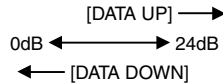

(b) Changing the minimum gain

- Move the “→” to MIN GAIN by pushing the [MENU UP], [MENU DOWN] buttons.
- Select the desired value of AGC minimum gain by pushing the [DATA UP], [DATA DOWN] buttons.

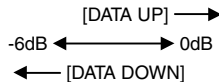

(2.2) Changing gain in MANUAL mode

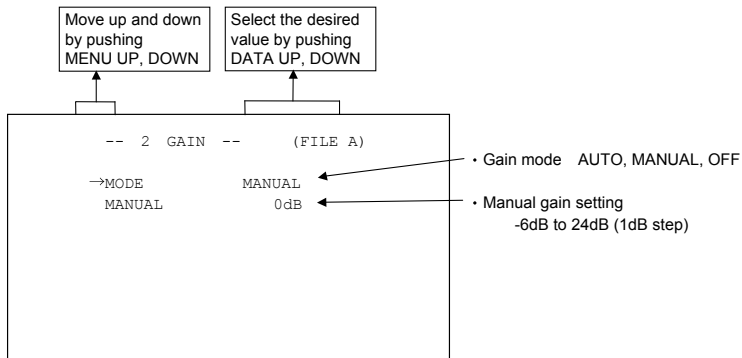

- ① Move the “→” to MANUAL by pushing the [MENU UP], [MENU DOWN] buttons.
- ② Select the desired value of manual gain by pushing the [DATA UP], [DATA DOWN] buttons.

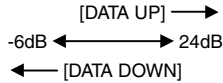

(3) WHT BAL (White balance)

The WHT BAL has two modes; AWB, MANUAL.

Move the “→” to MODE, push the [DATA UP], [DATA DOWN], and select one of the two modes: AWB, MANUAL.

(3.1) Changing the setting in AWB (Automatic White Balance) mode

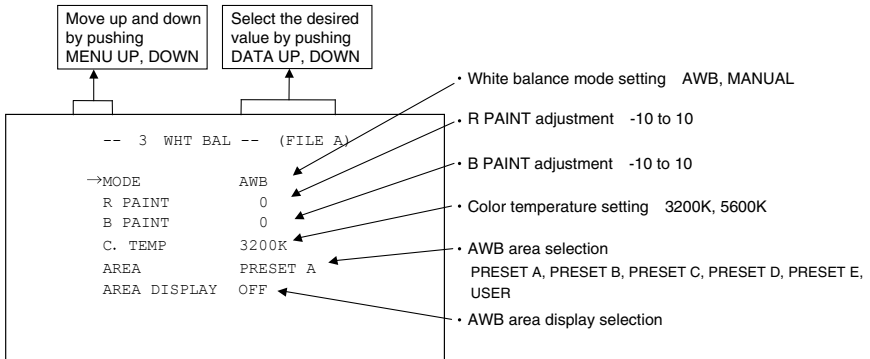

(a) Changing color temperature setting

- ① Move the “→” to C.TEMP by pushing the [MENU UP], [MENU DOWN] buttons.
- ② Select either 3200K or 5600K by pushing the [DATA UP], [DATA DOWN] buttons.

(b) Changing R PAINT

- ① Move the “→” to R PAINT by pushing the [MENU UP], [MENU DOWN] buttons.
- ② Select the desired value of red paint by pushing the [DATA UP], [DATA DOWN] buttons.



(c) Changing B PAINT

- ① Move the “→” to B PAINT by pushing the [MENU UP], [MENU DOWN] buttons.
- ② Select the desired value of blue paint by pushing the [DATA UP], [DATA DOWN] buttons.

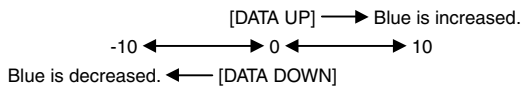

(d) Changing the contents of the zone area selected by AWB

- ① Move the “→” to AREA DISP by pushing the [MENU UP], [MENU DOWN] buttons.
- ② Select the desired area by pushing the [DATA UP], [DATA DOWN] buttons.

The dark squares indicate the effective region of the image, which is divided into an 8 x 8 grid.

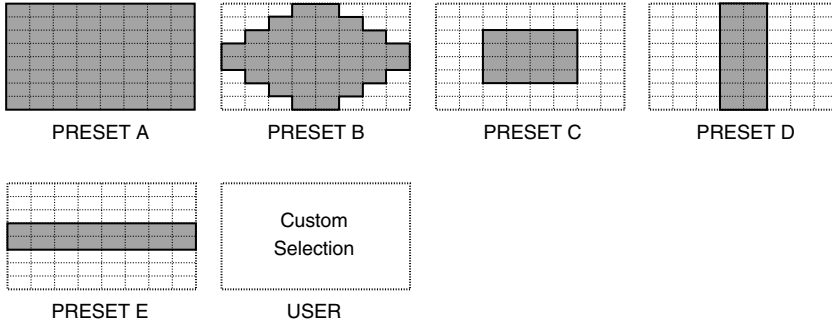

(e) Confirming the contents of the zone area selected by AWB

- ① Move the "→" to AREA DISP by pushing the [MENU UP], [MENU DOWN] buttons.
- ② Area screen appears by pushing the [DATA UP], [DATA DOWN] buttons.
When AREA is set to USER, the setting can be changed on the area menu. When changing the area, refer to the item "7.2 (9) Setting USER area".
- ③ Push the [DISP] button to return to the menu.

(3.2) Changing gain in MANUAL mode

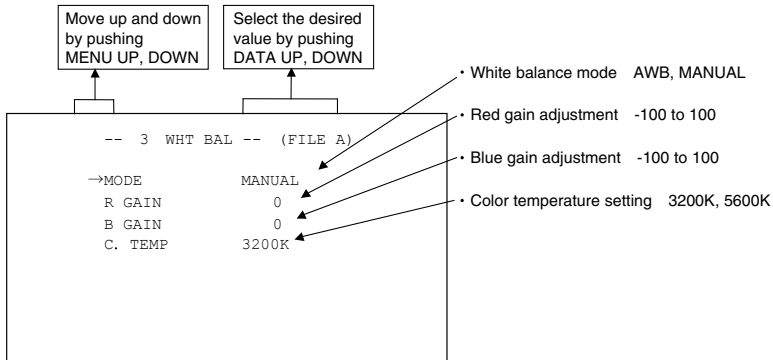

(a) Changing the red gain

- ① Move the "→" to R GAIN by pushing the [MENU UP], [MENU DOWN] buttons.
- ② Select the desired value of red gain by pushing the [DATA UP], [DATA DOWN] buttons.

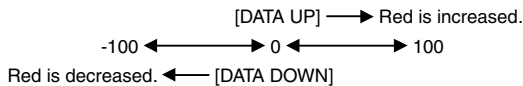

(b) Changing the blue gain

- ① Move the "→" to B GAIN by pushing the [MENU UP], [MENU DOWN] buttons.
- ② Select the desired value of blue gain by pushing the [DATA UP], [DATA DOWN] buttons.

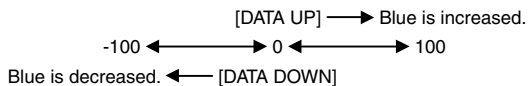

(4) PROCESS1

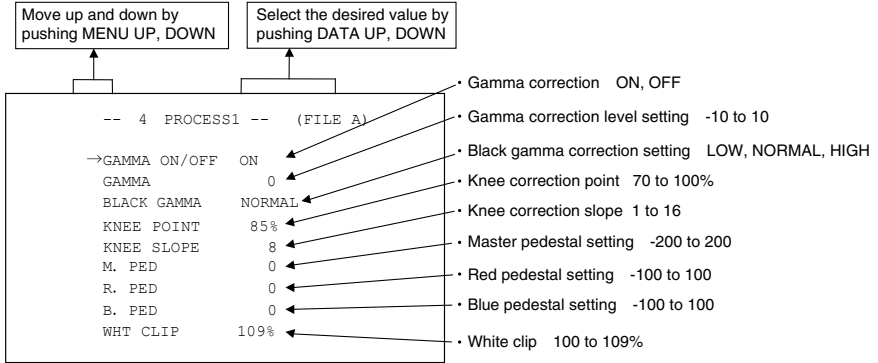

(4.1) Changing gamma correction ON/OFF

① Move the “->” to GAMMA ON/OFF by pushing the [MENU UP], [MENU DOWN] buttons.

② Select either ON or OFF by pushing the [DATA UP], [DATA DOWN] buttons.

When ON is selected, menu will show the GAMMA, BLACK GAMMA, KNEE POINT and KNEE SLOPE selections.

When OFF is selected, GAMMA, BLACK GAMMA, KNEE POINT and KNEE SLOPE are not displayed, so the setting for GAMMA, BLACK GAMMA, KNEE POINT and KNEE SLOPE cannot be made.

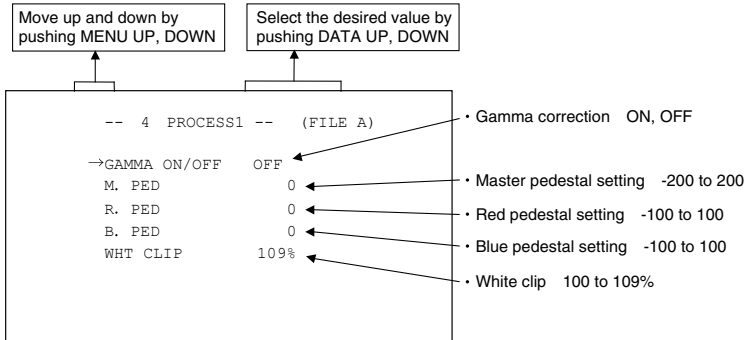

Menu when GAMMA OFF is selected.

(4.2) Changing gamma correction level

① Move the “->” to GAMMA by pushing the [MENU UP], [MENU DOWN] buttons.

② Select the desired value of gamma correction level by pushing the [DATA UP], [DATA DOWN] buttons.

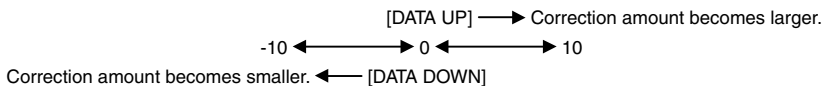

* When OFF is selected in GAMMA ON/OFF selection line, the GAMMA display disappears, so it cannot be changed.

(4.3) Changing black gamma correction level

- ① Move the “→” to BLACK GAMMA by pushing the [MENU UP], [MENU DOWN] buttons.
- ② Select black gamma correction by pushing the [DATA UP], [DATA DOWN] buttons.

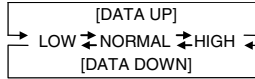

* When OFF is selected in GAMMA ON/OFF selection line, the BLACK GAMMA display disappears, so the black gamma correction level cannot be changed.

(4.4) Changing the knee correction point

- ① Move the “→” to KNEE POINT by pushing the [MENU UP], [MENU DOWN] buttons.
- ② Select the knee correction point by pushing the [DATA UP], [DATA DOWN] buttons.

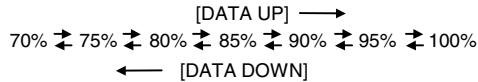

* When OFF is selected for GAMMA ON/OFF, the KNEE POINT display disappears, so it cannot be changed.

(4.5) Changing the knee correction slope

- ① Move the “→” to KNEE SLOPE by pushing the [MENU UP], [MENU DOWN] buttons.
- ② Select the knee correction slope by pushing the [DATA UP], [DATA DOWN] buttons.

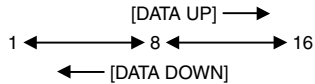

* When OFF is selected in GAMMA ON/OFF the KNEE SLOPE display disappears, so it cannot be changed.

(4. 6) Changing pedestal

(a) Changing master pedestal

- ① Move the "→" to M. PED by pushing the [MENU UP], [MENU DOWN] buttons.
- ② Select the desired value of the master pedestal by pushing the [DATA UP], [DATA DOWN] buttons.

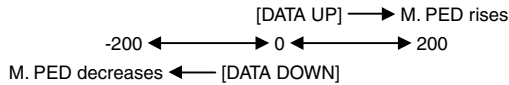

(b) Changing R. PED (red pedestal)

- ① Move the "→" to R. PED by pushing the [MENU UP], [MENU DOWN] buttons.
- ② Select the desired value of red pedestal by pushing the [DATA UP], [DATA DOWN] buttons.

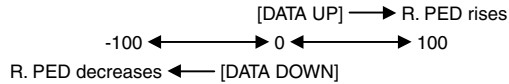

(c) Changing B. PED (blue pedestal)

- ① Move the "→" to B. PED by pushing the [MENU UP], [MENU DOWN] buttons.
- ② Select the desired value of blue pedestal by pushing the [DATA UP], [DATA DOWN] buttons.



(4. 7) Change of white clip

- ① Move the "→" to WHT CLIP by pushing the [MENU UP], [MENU DOWN] buttons.
- ② Select the white clip level by pushing the [DATA UP], [DATA DOWN] buttons.

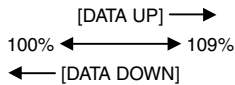

(5) PROCESS2

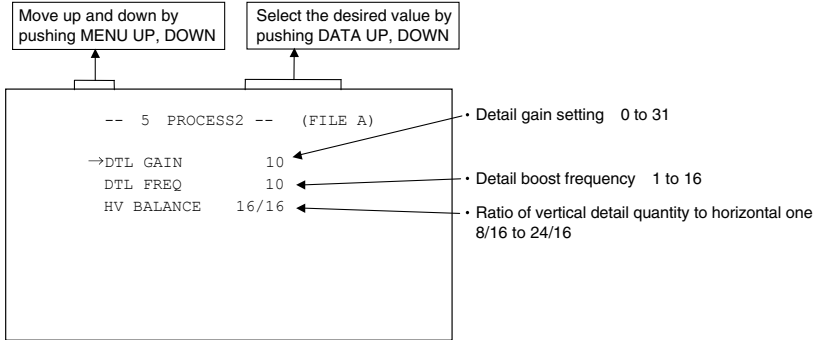

(5.1) Changing detail (outline) gain

- ① Move the “->” to DTL GAIN by pushing the [MENU UP], [MENU DOWN] buttons.
- ② Select the desired value of the detail gain by pushing the [DATA UP], [DATA DOWN] buttons.

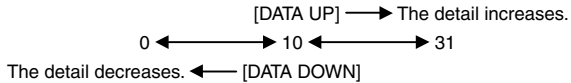

Note:

Settings can be configured for each output mode. (1080p and 1080i settings are shared.)

(5.2) Change of detail boost frequency

- ① This is the item for setting the screen outline thickness.
- ② Move the “->” to DTL FREQ by pushing the [MENU UP], [MENU DOWN] buttons.
Select the detail boost frequency by pushing the [DATA UP], [DATA DOWN] buttons.

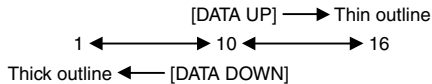

Note:

Settings can be configured for each output mode. (1080p and 1080i settings are shared.)

(5.3) Change of horizontal and vertical detail balance

- ① This is the item for changing the ratio of the vertical detail quantity to the horizontal one.
- ② Move the “->” to HV BALANCE by pushing the [MENU UP], [MENU DOWN] buttons.
Select the vertical detail quantity by pushing the [DATA UP], [DATA DOWN] buttons.

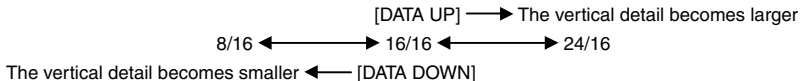

Note:

Settings can be configured for each output mode. (1080p and 1080i settings are shared.)

(6) PROCESS3

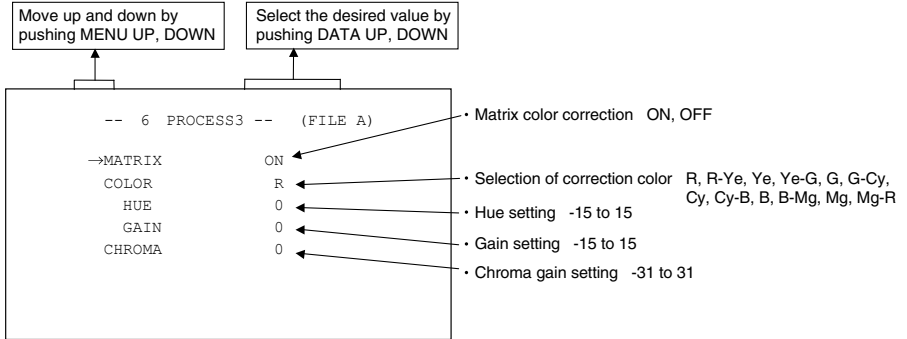

(6. 1) Changing matrix color correction ON/OFF

- ① Move the “→” to MATRIX by pushing the [MENU UP], [MENU DOWN] buttons.
- ② Select either ON or OFF by pushing the [DATA UP], [DATA DOWN] buttons.

(6. 2) Selection of color for correction

- ① Move the “→” to COLOR by pushing the [MENU UP], [MENU DOWN] buttons.
- ② Select the correction color by pushing the [DATA UP], [DATA DOWN] buttons.

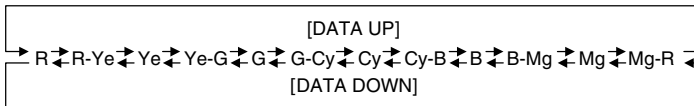

* If the matrix color correction is OFF, correction color cannot be selected.

(6. 3) Changing HUE and GAIN of selected color

- ① Move the “→” to the desired item by pushing the [MENU UP], [MENU DOWN] buttons.
- ② Select the desired value of color by pushing the [DATA UP], [DATA DOWN] buttons.

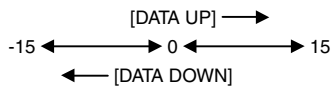

* If the matrix color correction is OFF, correction color cannot be selected.

(6. 4) Changing the total Chroma gain (simultaneously for all colors in the matrix)

- ① Move the “→” to CHROMA by pushing the [MENU UP], [MENU DOWN] buttons.
- ② Change the chroma gain by pushing the [DATA UP], [DATA DOWN] buttons.

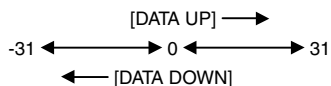

(7) SYNC

When an external sync signal is input, the display changes from INT (internal sync) to EXT. (external sync) automatically.

INT ←→ EXT

(7.1) INT screen

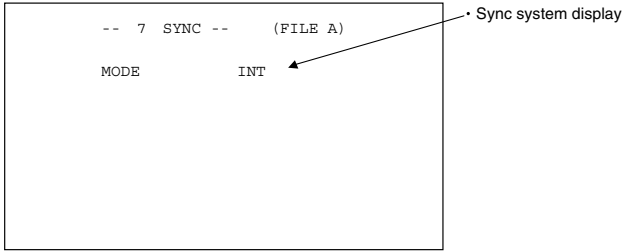

(7.2) Changing EXT. setting

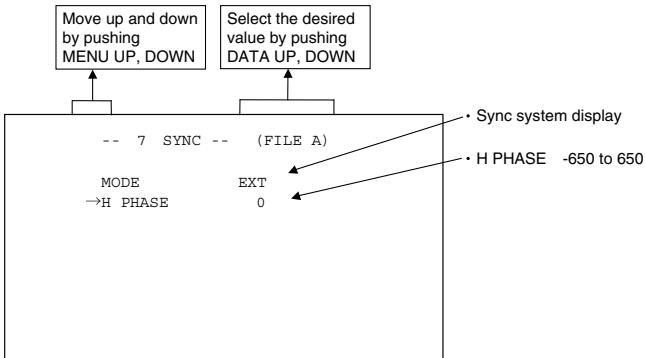

(a) Adjusting horizontal phase

- ① When in EXT mode, the "→" will be at H PHASE.
- ② Select the desired value of horizontal phase by pushing the [DATA UP], [DATA DOWN] buttons.

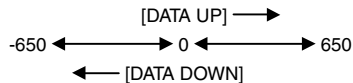

* If the phase difference is big, keep pressing [DATA UP]/[DATA DOWN] button for a while. This will make the setting change by increments of ten.

(8) OPTION

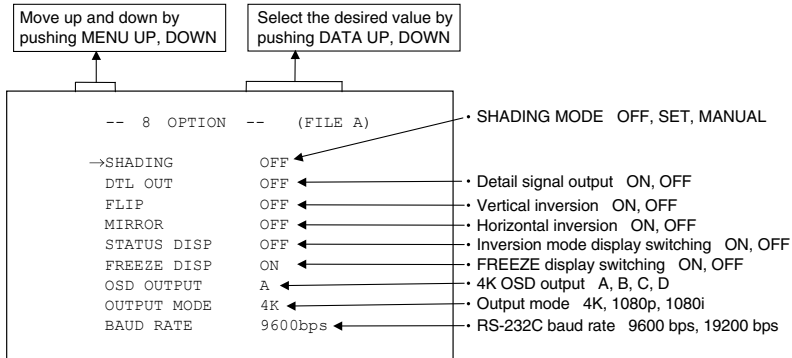

(8.1) Changing shading correction mode

- ① Move the "→" to SHADING by pushing the [MENU UP], [MENU DOWN] buttons.
- ② Select SET, MANUAL or OFF by pushing the [DATA UP], [DATA DOWN] buttons.

(8.2) Changing manual shading correction mode

- ① Move the "→" to MANUAL by pushing the [MENU UP], [MENU DOWN] buttons.
- ② Select the desired value of manual shading correction by pushing the [DATA UP], [DATA DOWN] buttons.

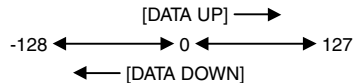

* When the shading correction mode is set to anything other than MANUAL, the display turns off, and the setting cannot be adjusted.

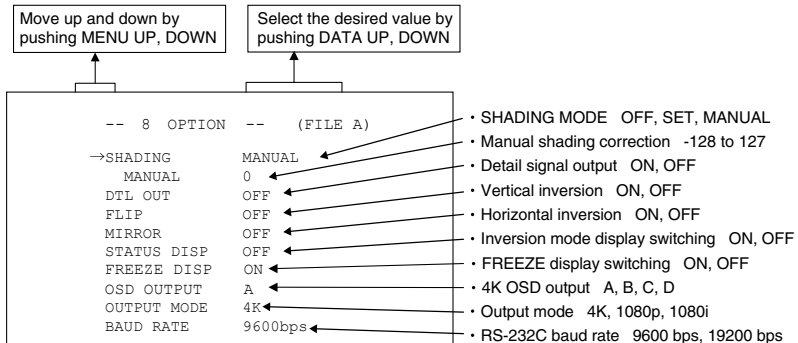

Menu when SHADING MANUAL is selected

(8.3) Changing detail signal output

- ① Move the "→" to DTL OUT by pushing the [MENU UP], [MENU DOWN] buttons.
- ② Select either ON (detail signal only is output) or OFF (video signal) by pushing the [DATA UP], [DATA DOWN] buttons.

(8. 4) Change of vertical inversion setting

- ① Move the “→” to FLIP by pushing the [MENU UP], [MENU DOWN] buttons.
- ② Select ON (Vertical inversion image appears.) or OFF by pushing the [DATA UP], [DATA DOWN] buttons.

(8. 5) Change of horizontal inversion setting

- ① Move the “→” to MIRROR by pushing the [MENU UP], [MENU DOWN] buttons.
- ② Select ON (Horizontal inversion image appears.) or OFF by pushing the [DATA UP], [DATA DOWN] buttons.

(8. 6) Switching of inversion mode display

- ① Move the “→” to STATUS DISP by pushing the [MENU UP], [MENU DOWN] buttons.
- ② Select ON or OFF by pushing the [DATA UP]-[DATA DOWN] buttons.

When ON is set, the setting status of vertical/horizontal inversion is displayed.

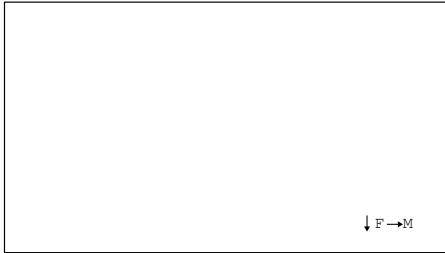

- ※ ↓ F...Vertical inversion is effective.
- ※ → M...Horizontal inversion is effective.

Note:

In the 4K mode, you can change the display position of setting status. (The position cannot be changed while the display is frozen.) (Refer to 7.2 (8) (8.8) “Changing 4K OSD (On Screen Display) output”.)

(8. 7) Changing the FREEZE display

- ① Use the [MENU UP] and [MENU DOWN] buttons to move “→” to FREEZE DISP.
- ② Use the [DATA UP] and [DATA DOWN] buttons to select ON or OFF.

If ON is selected “FREEZE” is displayed while the display is frozen.

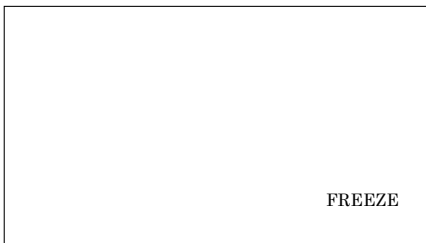

Note:

In the 4K mode, you can change the display position of “FREEZE”. (The position cannot be changed while the display is frozen.) (Refer to 7.2 (8) (8.8) “Changing 4K OSD (On Screen Display) output”.)

(8. 8) Changing 4K OSD (On Screen Display) output

- ① Use the [MENU UP] and [MENU DOWN] buttons to move “→” to OSD OUTPUT.
- ② Use the [DATA UP] and [DATA DOWN] buttons to select a letter from A to D.

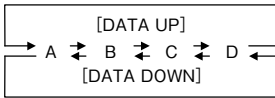

- If you select A, the OSD characters appear in the upper left corner of the monitor.
- If you select B, the OSD characters appear in the upper right corner of the monitor.
- If you select C, the OSD characters appear in the lower left corner of the monitor.
- If you select D, the OSD characters appear in the lower right corner of the monitor.

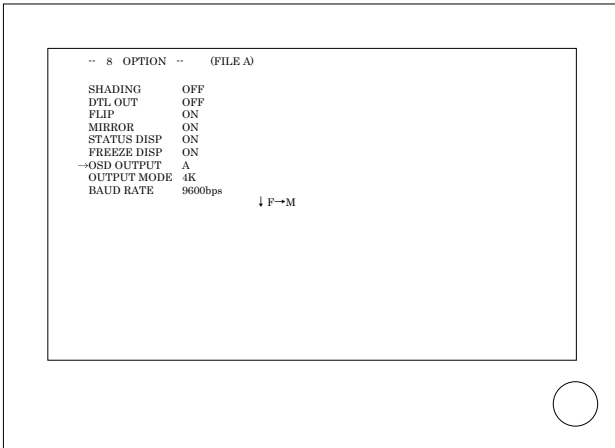

Example screen when OSD OUTPUT A is selected

- * If OUTPUT MODE is 1080p or 1080i, OSD OUTPUT disappears from the screen and the setting cannot be configured.

(8. 9) Changing the output mode

- ① Use the [MENU UP] and [MENU DOWN] buttons to move “→” to OUTPUT MODE.
- ② Use the [DATA UP] and [DATA DOWN] buttons to select 4K, 1080p, or 1080i.

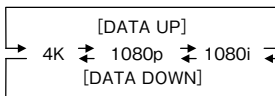

Note:

An image will not appear on a monitor that is not supported by the currently selected mode. If this happens, refer to 6.6 ① “Switching of OUTPUT modes” to return to the previous mode.

(8. 10) Changing RS-232C baud rate

- ① Move the “→” to BAUD RATE by pushing the [MENU UP], [MENU DOWN] buttons.
- ② Select either 9600bps or 19200bps by pushing the [DATA UP], [DATA DOWN] buttons.

(9) Setting USER area

- When USER is selected for the AREA of the automatic shutter or for AWB, the light measurement zones can be changed.
- The USER area is composed of 64 zones with 8 (vertical) x 8 (horizontal) areas, and each area can be set to ON/OFF.

① Set the output to area menu.

Set the output to the area menu by referring to the item “7.2 (1) (1.1) (f) Confirming the contents of the measurement light area selected by automatic shutter” and “7.2 (3) (3.1) (e) Confirming the contents of the zone area selected by AWB”.

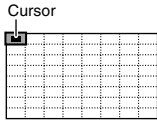

② Move the cursor to the zone to be modified.

The cursor moves up, down, right and left by pushing the [MENU UP], [MENU DOWN], [DATA UP], [DATA DOWN] buttons.

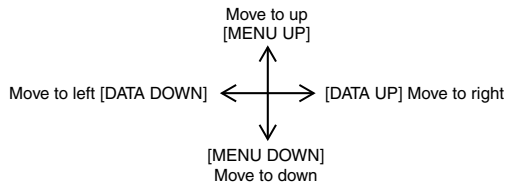

③ Select ON/OFF for the zone.

Select ON (effective) or OFF (ineffective) by pushing the [PAGE] button

When ON is selected, the selected area will be displayed brightly, and when OFF is selected, it will be dimmed.

④ Push [DISP] button to return to the menu.

Note:

OFF cannot be selected for all 64 zones because the automatic shutter function and AWB function will not perform correctly. (“AREA NG NOT AVAILABLE” displays.)

(10) Returning to factory settings

The contents set of each scene file can be returned to the factory default status (preset status).

- (1) Select a scene file to set to the factory default status by pressing the [FILE] button.
- (2) If the color bar pattern or characters are displayed on the screen, press the [DISP] button to disable the color bar pattern and character display.
- (3) Push [MENU DOWN] and [DATA DOWN] buttons simultaneously for approx. 1 second.
- (4) The preset operation starts. When the preset operation finishes, the character PRESET OK is displayed for approx. 1 second.

* Only the scene files selected presently are set at the time of shipment from the factory. If you wish to have all the scene files set as the factory shipment setting, perform the above operation for each scene file.

7.3 External Sync

When using the unit with an external sync signal, switch the SYNC switch to the IN side on the rear panel and then input the external sync signal to the SYNC IN/OUT terminal.

When the external sync signal is input, the camera automatically switches its sync from the internal sync to the external sync.

(1) External sync signal input conditions

Tri-Level Sync 0.6V(p-p) 75Ω unbalanced

(2) External sync frequency range

4K/59.94Hz Setting	: H : 67.433 kHz ± 35 ppm
	: V : 59.94 Hz ± 35 ppm
4K/50Hz Setting	: H : 56.250 kHz ± 35 ppm
	: V : 50 Hz ± 35 ppm
1080p/59.94Hz Setting	: H : 67.433 kHz ± 35 ppm
	: V : 59.94 Hz ± 35 ppm
1080p/50Hz Setting	: H : 56.250 kHz ± 35 ppm
	: V : 50 Hz ± 35 ppm
1080i/59.94Hz Setting	: H : 33.716 kHz ± 35 ppm
	: V : 59.94 Hz ± 35 ppm
1080i/50Hz Setting	: H : 28.125 kHz ± 35 ppm
	: V : 50 Hz ± 35 ppm

(3) Using the unit with external sync signal

Adjust H (Horizontal) phase if necessary to match the output of multiple cameras.

When adjusting H (Horizontal) phase, refer to the item "7.2 (7) SYNC".

Note:

This unit cannot use external sync input and sync signal output at the same time.

7.4 Synchro. Scan Operation

The shutter speed can be set by the horizontal scanning period (1H).

(1) Setting by 1H

1/1125H to 1124/1125H - lets you set a shutter speed to any fraction of the horizontal scanning period from 1/1125H to 1124/1125H in increments of 1.

8. BEFORE MAKING SERVICE CALL

Symptom	Items to be checked
No image	<ul style="list-style-type: none">• Is power supplied correctly?• Is the power switch on, and the power LED illuminated?• Is the lens iris adjusted correctly?• Are the camera and video cables connected correctly?• Is the shutter mode set correctly?• Is the monitor on, and in working condition?• Is the image signal output mode set correctly?
Poor color	<ul style="list-style-type: none">• Is the monitor adjusted correctly?• Is the white balance of the camera adjusted correctly?• Are the matrix color correction and chroma gain set correctly?• Is the illumination sufficient?
Noise appears	<ul style="list-style-type: none">• Is the camera cable connected securely?
"HEAD COMPATIBILITY ERROR" is displayed	<ul style="list-style-type: none">• Is the camera head that is connected compatible with the unit?

9. SPECIFICATIONS

* These conditions are only satisfied when the camera control unit is connected to camera head model # IK-4KH.

Power supply	DC 12 V \pm 10 %
Power consumption	Approx. 13.8W (including the camera head) (with the power supply voltage of 12V)
Pickup system	RGB, 3CMOS, Micro prism system
Image sensor	1/2.9 inch CMOS
Effective pixels	Horizontal: 1944 pixels, vertical: 1104 pixels
Output pixels	Horizontal: 3840pixels, vertical: 2160 pixels (4K) Horizontal: 1920 pixels, vertical: 1080 pixels (1080p or 1080i)
Scanning system	Progressive (4K or 1080p) / Interlace (1080i)
Scan frequency	Horizontal: 67.433kHz, vertical: 59.94Hz (at setting of 4K/59.94Hz, Square Division) Horizontal: 56.250kHz, vertical: 50Hz (at setting of 4K/50Hz, Square Division) Horizontal: 67.433kHz, vertical: 59.94Hz (at setting of 1080p/59.94Hz) Horizontal: 56.250kHz, vertical: 50Hz (at setting of 1080p/50Hz) Horizontal: 33.716kHz, vertical: 59.94Hz (at setting of 1080i/59.94Hz) Horizontal: 28.125kHz, vertical: 50Hz (at setting of 1080i/50Hz)
Sync system	Internal/External (Automatic switching)
Horizontal resolution	1600TV lines standard (4K) 1000TV lines or more (1080p or 1080i)
Vertical resolution	1600TV lines standard (4K) 1000TV lines or more (1080p or 1080i)
Sensitivity	F5.6 standard (2000 lx, 3000K at 59.94Hz setting) F6.1 standard (2000 lx, 3000K at 50Hz setting)
Minimum illumination	19.5 lx (at 59.94Hz setting, F2.2, GAIN +24dB) 16.2 lx (at 50Hz setting, F2.2, GAIN +24dB)
SN ratio	58 dB standard (GAIN : 0dB, DTL GAIN : 0, GAMMA : OFF, MATRIX : OFF, C.TEMP : 5600K, during light elimination)
Ambient temperature	0°C to 40°C (32°F to 104°F)
Ambient humidity	Less than 90% (non condensing)
Weight	Approx. 800 g (1.76 lbs)
External dimension	110(W) \times 40(H) \times 196(D) mm (4.33"(W) \times 1.57"(H) \times 7.72"(D)) (excluding protrusions)
Scene file (user memories)	A, B, C, D, E
White balance	AWB (Automatic white balance), MANUAL
Gain	AUTO (Automatic gain control), MANUAL, OFF (0dB)
Output signal	3G-SDI/HD-SDI output x 4 3G-SDI (SMPTE 424M compliant, SMPTE 425M Level A), 0.8 V (p-p), 75 Ω unbalanced, BNC connector 4K/59.94p Square Division, 4K/50p Square Division, 1080/59.94p, 1080/50p HD-SDI (SMPTE 292M compliant) 0.8 V (p-p), 75 Ω unbalanced, BNC connector 1080/59.94i, 1080/50i
External sync input	Tri-Level Sync 0.6V(p-p) 75 Ω unbalanced BNC connector Horizontal: 67.433kHz \pm 35ppm, vertical 59.94Hz \pm 35ppm (at 4K/59.94Hz setting) Horizontal: 56.250kHz \pm 35ppm, vertical 50Hz \pm 35ppm (at 4K/50Hz setting) Horizontal: 67.433kHz \pm 35ppm, vertical 59.94Hz \pm 35ppm (at 1080p/59.94Hz setting) Horizontal: 56.250kHz \pm 35ppm, vertical 50Hz \pm 35ppm (at 1080p/50Hz setting) Horizontal: 33.716kHz \pm 35ppm, vertical 59.94Hz \pm 35ppm (at 1080i/59.94Hz setting) Horizontal: 28.125kHz \pm 35ppm, vertical 50Hz \pm 35ppm (at 1080i/50Hz setting)
Sync signal output	Tri-Level Sync 0.6V(p-p) 75 Ω unbalanced BNC connector Horizontal: 67.433kHz \pm 35ppm, vertical 59.94Hz \pm 35ppm (at 4K/59.94Hz setting) Horizontal: 56.250kHz \pm 35ppm, vertical 50Hz \pm 35ppm (at 4K/50Hz setting) Horizontal: 67.433kHz \pm 35ppm, vertical 59.94Hz \pm 35ppm (at 1080p/59.94Hz setting) Horizontal: 56.250kHz \pm 35ppm, vertical 50Hz \pm 35ppm (at 1080p/50Hz setting) Horizontal: 33.716kHz \pm 35ppm, vertical 59.94Hz \pm 35ppm (at 1080i/59.94Hz setting) Horizontal: 28.125kHz \pm 35ppm, vertical 50Hz \pm 35ppm (at 1080i/50Hz setting)
Interface	Serial data interface (compliant with RS-232C)
Optional parts	IK-4KH (1/2.9 inch 3CMOS camera head) EXC-3HD03 (Approx. 3 m (118") Camera cable), EXC-3HD06 (Approx. 6 m (236") Camera cable) EXC-3HD10 (Approx. 10 m (394") Camera cable), EXC-3HD15 (Approx. 15 m (591") Camera cable)

● Design and specifications are subject to change without notice.

10. EXTERNAL APPEARANCE DIAGRAM

Unit : mm [inch]

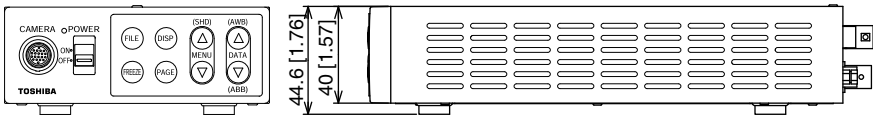
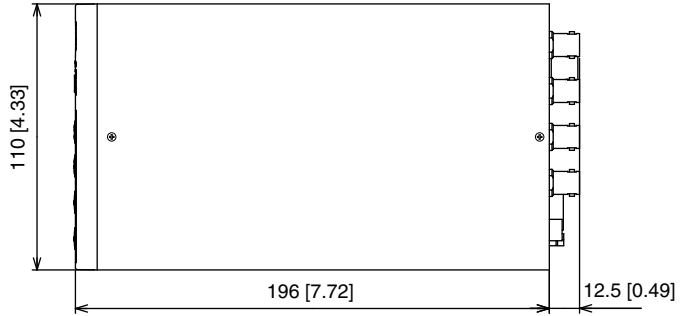

[Front]

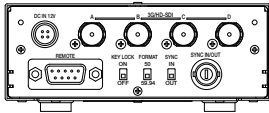

[Rear]

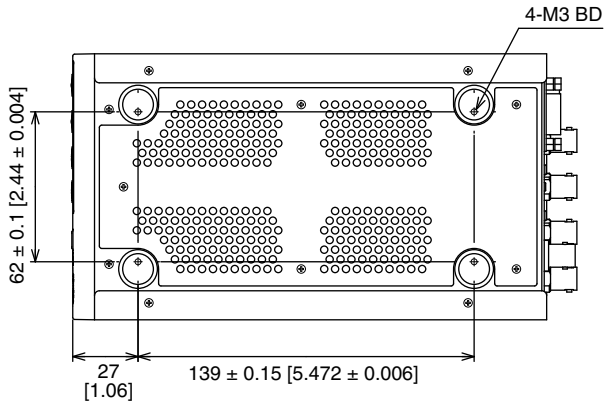

Limited Warranty – TOSHIBA Camera Control Unit

The Imaging Systems Division of Toshiba America Information Systems, Inc. ("ISD") makes the following limited warranty with regard to this Camera Control Unit ("Product"). These limited warranties apply to the Original End-User "You(r)".

One (1) Year Limited Warranty of Labor and Parts

ISD warrants that this Product will perform in accordance with specifications for a period of one (1) year from the date of purchase by the Original End-User. During this one (1) year period, ISD will repair or replace the Product, if it does not perform as warranted. In order to take advantage of this Limited Warranty, You must: (a) deliver the Product to an ISD Authorized Service Provider ("ASP"); and (b) pay all transportation and insurance charges for shipment of the Product to the ASP. ISD reserves the right to substitute factory refurbished parts in place of those in need of repair.

Instruction Manual (Owner's Manual):

You should read the Instruction Manual (Owner's Manual) thoroughly before operating this Product. Before seeking warranty service, you should check the troubleshooting guide in the Instruction Manual (Owner's Manual) and follow the instructions to correct the problem.

Warranty service under this Limited Warranty is subject to the following conditions and procedures:

1. All warranty servicing of the Product must be made by an ASP (Authorized Service Provider).
2. You must notify an ASP within thirty (30) days after You discover that the Product does not perform in accordance with specifications during the Limited Warranty period.
3. You must securely pack the Product in its original carton using the original packing material.
4. You must insert the original carton containing the Product, a letter explaining the problem AND a copy of the bill of sale or proof of purchase into another carton with additional packing material before shipping the Product to an ASP.
5. You must prepay all transportation and insurance costs.

DISCLAIMERS:

ALL OTHER EXPRESS OR IMPLIED WARRANTIES ON THIS PRODUCT, INCLUDING THE IMPLIED WARRANTIES OF MERCHANTABILITY AND FITNESS FOR A PARTICULAR PURPOSE, ARE HEREBY DISCLAIMED. SOME STATES DO NOT ALLOW THE EXCLUSION OF IMPLIED WARRANTIES OR LIMITATIONS ON HOW LONG AN IMPLIED WARRANTY LASTS, SO THE ABOVE LIMITATIONS MAY NOT APPLY TO YOU.

IF THIS PRODUCT IS NOT IN GOOD WORKING ORDER AS WARRANTED ABOVE, YOUR SOLE AND EXCLUSIVE REMEDY SHALL BE THE REPAIR OR REPLACEMENT OF THE PRODUCT. IN NO EVENT WILL ISD OR ITS PARENT COMPANY OR ANY ASP BE LIABLE TO YOU OR ANY THIRD PARTY FOR ANY DAMAGES IN EXCESS OF THE PURCHASE PRICE OF THE PRODUCT. THIS LIMITATION APPLIES TO DAMAGES OF ANY KIND, INCLUDING ANY DIRECT OR INDIRECT DAMAGES, LOST PROFITS, LOST SAVINGS OR OTHER SPECIAL, INCIDENTAL, EXEMPLARY OR CONSEQUENTIAL DAMAGES, WHETHER FOR BREACH OF CONTRACT, TORT OR OTHERWISE, OR WHETHER ARISING OUT OF THE USE OF OR INABILITY TO USE SUCH PRODUCT, EVEN IF ISD, ITS PARENT COMPANY, OR AN ASP HAS BEEN ADVISED OF THE POSSIBILITY OF SUCH DAMAGES OR OF ANY CLAIM BY ANY OTHER PARTY. SOME STATES DO NOT ALLOW THE EXCLUSION OR LIMITATION OF INCIDENTAL OR CONSEQUENTIAL DAMAGES FOR SOME PRODUCTS, SO THE ABOVE LIMITATIONS OR EXCLUSIONS MAY NOT APPLY TO YOU.

THIS LIMITED WARRANTY GIVES YOU SPECIFIC LEGAL RIGHTS, AND YOU MAY ALSO HAVE OTHER RIGHTS WHICH MAY VARY FROM STATE TO STATE.

THIS LIMITED WARRANTY SHALL BE VOID IF THE PRODUCT OR PARTS HAVE BEEN SUBJECTED TO MISUSE, ABUSE, ACCIDENT, IMPROPER INSTALLATION, IMPROPER MAINTENANCE, OR USE IN VIOLATION OF ISD'S WRITTEN INSTRUCTIONS, OR WHERE THE PRODUCT HAS BEEN ALTERED OR MODIFIED WITHOUT ISD'S PRIOR AUTHORIZATION, OR UPON THE REMOVAL OR ALTERATION OF ISD'S FACTORY SERIAL NUMBER. LABOR SERVICE CHARGES FOR PRODUCT INSTALLATION, SET UP AND ADJUSTMENT OF CONTROLS ARE NOT COVERED BY THIS LIMITED WARRANTY.

Questions? If you have any questions, including information on Authorized Service Providers and current e-mail for contact support, please check ISD's Web Site for current information:

Web Site: <http://www.toshibacameras.com/>

No person, agent, distributor, dealer, authorized service provider, or company is authorized to change, modify, or extend the terms of this Limited Warranty in any manner whatsoever. The time within which an action must be commenced to enforce any obligation of ISD arising under this Limited Warranty or under any statute, or law of the United States or any state thereof, is hereby limited to one (1) year from the end of the Limited Warranty period. This limitation does not apply to implied warranties arising under state law. Some states do not permit limitation of the time within which You may bring an action beyond the limits provided by state law, so the above provision may not apply to You. This Limited Warranty gives You specific legal rights and You may also have other rights which vary from state to state.

TOSHIBA AMERICA INFORMATION SYSTEMS, INC.

Imaging Systems Division

9740 Irvine Boulevard, Irvine, CA 92618-1697

Copyright © 2014 Toshiba corporation, Toshiba America Information Systems, Inc. All rights reserved.

This manual is made from recycled paper.

TOSHIBA